



Operating Instructions
combiSENSOR KSB6430-PROFINET

MICRO-EPSILON
MESSTECHNIK
GmbH & Co. KG
Koenigbacher Straße 15

94496 Ortenburg / Germany

Tel. +49 (0) 8542 / 168-0
Fax +49 (0) 8542 / 168-90
info@micro-epsilon.com
www.micro-epsilon.com

Inhalt

1.	Safety	5
1.1	Symbols Used	5
1.2	Warnings	5
1.3	Notes on Product Marking	6
1.3.1	CE Marking.....	6
1.3.2	UKCA Marking.....	6
1.4	Intended Use	7
1.5	Proper Environment.....	7
2.	Functional Principle, Options, Technical Data	8
2.1	Measuring Principle.....	8
2.1.1	Capacitive Measuring Principle	8
2.1.2	Eddy Current Measuring Technique	9
2.1.3	Thickness Determination	9
2.2	Structure	11
2.2.1	Sensor	11
2.2.2	Sensor Cable.....	12
2.2.3	Controller KSB6430.....	12
2.3	Technical Data	13
3.	Delivery	14
3.1	Unpacking, Included in Delivery	14
3.2	Storage	14
4.	Installation and Assembly	15
4.1	Precautions.....	15
4.2	Sensor.....	15
4.3	Sensor Cable.....	16
4.4	Controller	17
4.5	Ground Connection, Grounding	18
4.6	Electrical Connections.....	19
4.6.1	Connection Possibilities	19
4.6.2	Pin Assignment Supply, Trigger.....	20
4.6.3	Analog Output	20
4.7	Fieldbus Cabling.....	21

5.	Operation	22
5.1	Initial Operation	22
5.2	Controller LEDs	22
5.3	Triggering.....	23
5.4	Measurement Averaging	25
	5.4.1 Preliminary Remarks	25
	5.4.2 Moving Mean.....	25
	5.4.3 Arithmetic Average	26
	5.4.4 Median.....	26
	5.4.5 Dynamic Noise Suppression	26
6.	Initial Operation	27
6.1	General	27
6.2	Basic Settings Module.....	27
6.3	Data Format	28
6.4	Object Directory.....	29
	6.4.1 Error Protocol.....	29
	6.4.2 Device Reset	29
	6.4.3 Triggering	29
	6.4.4 Filter Settings	30
	6.4.5 Sample Time	30
	6.4.6 Thickness Measurements.....	31
	6.4.7 Thickness Measurement Zero Setting.....	31
6.5	Sequence when Writing and Reading Acyclical Data.....	32
6.6	Sequence when Writing Structured Data.....	33
7.	Operation and Maintenance.....	34
8.	Disclaimer	35
9.	Decommissioning, Disposal	36
Appendix		
A 1	Accessories	37
A 2	Integration into TIA Portal	38
A 2.1	Importing KSB6430 into the Software.....	38
A 2.2	Unique Integration of KSB6430 into the PROFINET Network	43
A 2.3	Loading the Configuration into the PLC.....	47
A 2.4	Accessing Input and Output Data	49

1. Safety

System operation assumes knowledge of the operating instructions.

1.1 Symbols Used

The following symbols are used in these operating instructions:



Indicates a hazardous situation which, if not avoided, may result in minor or moderate injury.



Indicates a situation that may result in property damage if not avoided.



Indicates a user action.



Indicates a tip for users.

1.2 Warnings



Disconnect the power supply before touching the sensor surface.
> Risk of injury due to static discharge

Connect the power supply and the display/output device according to the safety regulations for electrical equipment.

- > Risk of injury
- > Damage to or destruction of the sensor and/or the controller.



NOTICE

Avoid shocks and impacts to the sensor and/or the controller.
> Damage to or destruction of the sensor and/or controller.

The supply voltage must not exceed the specified limits.
> Damage to or destruction of the sensor and/or controller.

Protect the cables against damage.
> Damage to sensor
> Failure of the measuring device

1.3 Notes on Product Marking

1.3.1 CE Marking

The following apply to the product:

- Directive 2014/30/EU ("EMC")
- Directive 2011/65/EU ("RoHS")

Products which carry the CE marking satisfy the requirements of the EU Directives cited and the relevant applicable harmonized European standards (EN). The product is designed for use in industrial and laboratory environments.

The EU Declaration of Conformity and the technical documentation are available to the responsible authorities according to the EU Directives.

1.3.2 UKCA Marking

The following apply to the product:

- SI 2016 No. 1091 ("EMC")
- SI 2012 No. 3032 ("RoHS")

Products which carry the UKCA marking satisfy the requirements of the directives cited and the relevant applicable harmonized standards. The product is designed for use in industrial and laboratory environments.

The UKCA Declaration of Conformity and the technical documentation are available to the responsible authorities according to the UKCA Directives.

1.4 Intended Use

- The combiSENSOR 6430 measuring system is designed for use in industrial and laboratory applications. It is used for
 - Film thickness measurement of plastics
 - Thickness measurement of insulators
 - Thickness measurement of conductive battery film
- The system must only be operated within the limits specified in the technical data, [see 2.3](#).
- The sensor must be used in such a way that no persons are endangered or machines and other material goods are damaged in the event of malfunction or total failure of the controller.
- Take additional precautions for safety and damage prevention in case of safety-related applications.

1.5 Proper Environment

- Protection class:
 - Sensor: IP54
 - Controller: IP40
- Operating temperature:
 - Sensor: -10 ... +180 °C (+14 ... +356 °F)
 - Sensor cable: -10 ... +125 °C (+14 ... +257 °F)
 - Controller: +10 ... +60 °C (+50 ... +140 °F)
- Humidity: 5 ... 95 % RH (non-condensing)
- Ambient pressure: Atmospheric pressure
- Storage temperature:
 - Sensor: -10 ... +100 °C (+14 ... +212 °F)
 - Sensor cable: -10 ... +100 °C (+14 ... +212 °F)
 - Controller: 0 ... +75 °C (+14 ... +167 °F)
- The space between sensor surface and target must have an unchanging dielectric constant.
- The space between the sensor surface and target must not be soiled (e.g. with water, abraded particles, dust, etc.).

2. Functional Principle, Options, Technical Data

2.1 Measuring Principle

The measurement coil and measurement electrodes have a concentric design. Thus, both measure against the same target surface. The signal of the capacitive displacement sensor is a function of the working distance, the thickness of the insulator and (ϵ_r). At the same time the eddy current displacement sensor measures the distance to the ground electrode (e.g. flat metal sheet or metal roller positioned behind the film). On the downstream controller, the measured values are output as analog voltages from 0 to 10 VDC and as digital signal via PROFINET.

2.1.1 Capacitive Measuring Principle

The capacitive distance measuring principle is based on the functioning of an ideal plate capacitor.

If a constant alternating current I_c flows through the sensor capacitor, the maximum value U_c of the alternating voltage at the sensor is proportional to the distance d between the capacitor electrodes.

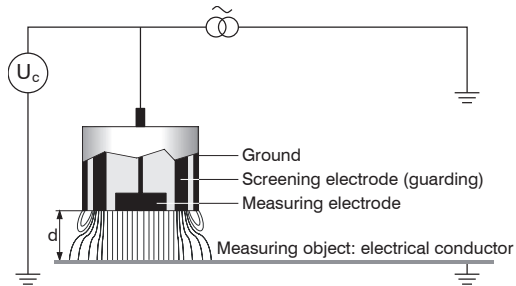

$$\left. \begin{aligned} X_c &= \frac{U_c}{I_c} = \frac{1}{\omega C} \\ C &= \epsilon_0 \epsilon_r \frac{A}{d} \end{aligned} \right\} U_c = \frac{I_c d}{\omega \epsilon_0 \epsilon_r A} \gg U_c \sim d$$

Fig. 1 Field line image of a capacitive sensor, no insulator material in the measuring gap

The measured alternating current is demodulated and amplified as, for example, an analog signal. As the sensor is designed as a guard ring capacitor, this ensures that the homogeneous electric field required in the ideal case is also almost realized in the practical measurement.

i A target that is too small and curved (uneven) surfaces to be measured also produce a non-linear characteristic curve.

2.1.2 Eddy Current Measuring Technique

The eddy current measurement method is used for measurements on objects made of electrically conductive materials, which may have ferromagnetic and non-ferromagnetic properties.

A high frequency alternating current is passed through a coil potted in a sensor housing. The electromagnetic field of the coil induces eddy currents in the conducting measuring object, whereby the resulting impedance of the coil changes.

This change of impedance causes an electrical signal which is proportional to the distance between the measuring object and the sensor.

A compensation method reduces temperature-dependent measurement errors to a minimum.

i If the material of the counter electrode is changed, the measuring system must be recalibrated.

2.1.3 Thickness Determination

The main area of application of the combiSENSOR is the traversing thickness measurement of

- plastic film,
- the thickness of plastic coatings on metal plates or
- battery film.

If measurements are taken on a conductive film, e.g. battery film, the value of the dielectric constant must be set to a very high value (> 100000) for the thickness measurement function.

Calculation of the two sensor signals provides compensation of mechanical changes such as thermal expansion, deflections or eccentricity in the measurement device, for example. Due to the redundancy of this combined sensor principle, the measured thickness value remains unaffected by any changes in the measurement setup. The measuring object thickness D is calculated from the two sensor signals.

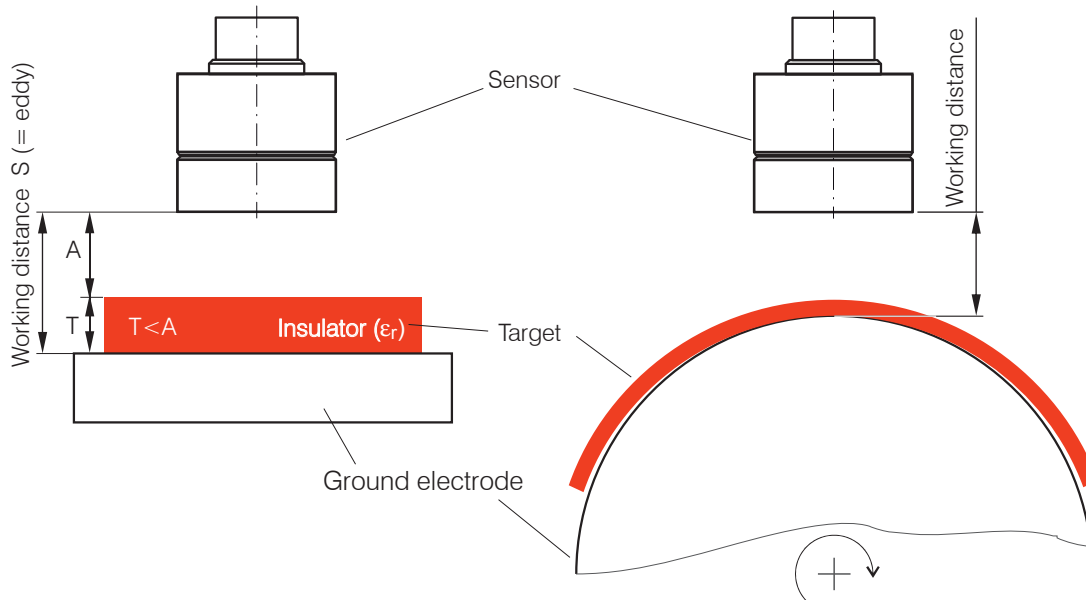

Fig. 2 Measurement arrangement for thickness measurement

The thickness of the insulator is calculated from the factors: Max. working distance, capacitive displacement measuring signal A and the dielectric constant of the insulator:

$$T = \left[S \text{ (eddy)} - A \text{ (capa)} \right] * \left[\frac{\epsilon_r}{\epsilon_r - 1} \right] * \frac{WD}{100 \% } + \text{Offset}$$

T	Thickness measuring object [μm]
S	Signal eddy current sensor [%]
A	Signal capacitive sensor [%]
ϵ_r	Dielectric constant film (insulator)
WD	Max. Working distance sensor [μm]
Offset	Constant [μm], standard value = 0

A constant dielectric constant of the medium to be measured is required for correct thickness measurement. The thickness value is calculated in the controller.

i With measuring objects presenting a structured surface, a target thickness up to a maximum of 50 % of the working distance is recommended. If necessary, use a sensor with a larger target thickness instead.

In contrast to the capacitive signal of the sensor, the output signal of the eddy current signal remains unaffected by the media in the measuring gap and is only determined by the distance between the sensor and the counter electrode.

2.2 Structure

The non-contact measuring system, see Fig. 13, which is built into an aluminum housing, consists of:

- Sensor KSH5 with sensor cable, one controller KSB6430.



Fig. 3 Single-channel measuring system with sensor and controller

2.2.1 Sensor

In its sensor housing, the combiSENSOR combines an eddy current displacement sensor and a capacitive displacement sensor. To achieve accurate measurement results, it is essential to keep the sensor face clean and prevent damage.

The capacitive measuring method is area-based. The combiSENSOR requires a minimum surface area of \varnothing 45 mm (KSH5).

2.2.2 Sensor Cable

Sensor and controller are connected via a special, double-shielded 1m-long KC1 sensor cable.

- ▶ Do not shorten or lengthen this special sensor cable. Do not kink the sensor cable. Do not change the sensor cable. This leads to a loss of functionality or the specified technical data.
- ▶ Lay the sensor cable in a protected area.

A damaged cable cannot be repaired. The sensor cable is not qualified for drag chain use.

Minimum bending radius: 20 mm (one-off), 80 mm (permanent).

- Switch off the power supply to the controller if you disconnect or change the cable connection.

2.2.3 Controller KSB6430

The controller combines the oscillator and the evaluation electronics for the sensor in one housing. The capacitive component and eddy current component in the sensor are synchronized with each other.

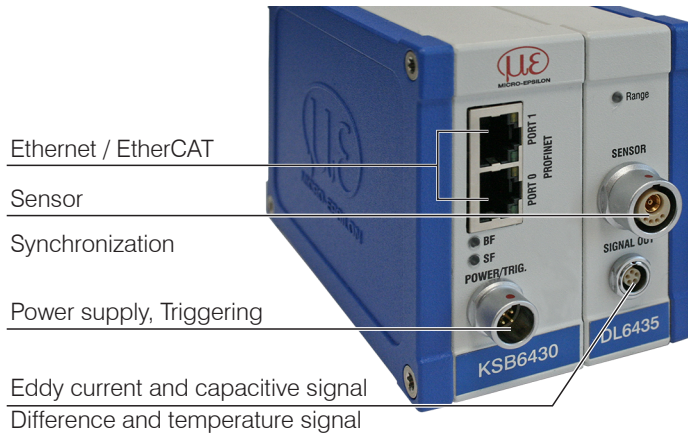

Fig. 4 Controller ports

2.3 Technical Data

Controller		KSB6430
Sensor		KSH5(03)
Target thickness insulator		5 μm ... 3 mm
Working distance		2.5 ... 4 mm (2 ... 5 mm with reduced accuracy)
Resolution	static 100 Hz	0.0004 %
	dynamic 3.9 kSa/s	0.0015 %
Frequency response		1 kHz (-3 dB)
Run-out error		< $\pm 1.5 \mu\text{m}^1$
Linearity		$\pm 0,05$ %
Temperature stability	Sensor	< ± 50 ppm/ $^{\circ}\text{C}$ (+10 ... +120 $^{\circ}\text{C}$)
	Controller	< ± 50 ppm/ $^{\circ}\text{C}$ (in typical measuring range 2,5 ... 4,0 mm)
Temperature range	Operation	Controller: +10 ... +60 $^{\circ}\text{C}$; Sensor: -10 ... +180 $^{\circ}\text{C}$; Sensor cable: -10 ... +125 $^{\circ}\text{C}$
	Storage	Sensor, Sensor cable: -10 ... +100 $^{\circ}\text{C}$, Controller: 0 ... 75 $^{\circ}\text{C}$
Supply voltage		12 ... 36 VDC, typ. 24 VDC (5.5 W)
Output	Analog	Capacitive, eddy current and thickness signal, temperature signal: 0...10 V (short circuit proof)
	PROFINET RT/IRT	Capacitive, eddy current and thickness signal, temperature signal: FLOAT
Digital data rate		Internal AD conversion up to 3.906 kSa/s (adjustable via software) PROFINET RT (down to 1000 μs) PROFINET IRT (down to 500 μs)
Trigger		TTL, 5 V
Measuring object		Straight surface or min. diameter 200 mm ² Coating, e.g., Chrome, at least 150 μm
Min. target size		$\varnothing 45$ mm
Protection class		Sensor: IP54, controller: IP 40
Weight		Sensor: 80 g; controller: 750 g

1) Error due to material inhomogeneities in ferromagnetic rollers during roller rotation, depending on material and coating thickness.

3. Delivery

3.1 Unpacking, Included in Delivery

- 1 Controller KSB6430
- 1 Sensor KSH5(03)
- 1 Sensor cable KC1 or KC1,5
- 1 Supply cable PC6200-3/4
- 1 Operating instructions

- ▶ Carefully remove the components of the measuring system from the packaging and ensure that the goods are forwarded in such a way that no damage can occur.
- ▶ Check the delivery for completeness and shipping damage immediately after unpacking.
- ▶ If there is damage or parts are missing, immediately contact the manufacturer or supplier.

3.2 Storage

- Storage temperature
 - Sensor, sensor cable: -10 ... +100 °C (+14 ... +212 °F)
 - Controller: 0 ... + 75 °C (+50 ... +167 °F)
- Humidity: 5 ... 95% RH (non-condensing)

4. Installation and Assembly

4.1 Precautions

No sharp or heavy objects should be allowed to affect the cable sheath.

In areas with increased pressure, the cable must always be protected from pressure loads.

The minimum bending radius is 20 mm. Kinks must be avoided at all costs.

The plug connections must be checked for firm seating.

i A damaged cable cannot be repaired.

4.2 Sensor

➤ During sensor mounting, take care that the polished sensor front face is not scratched.

i Measuring object may not touch the sensor front face. Maintain the working distance.

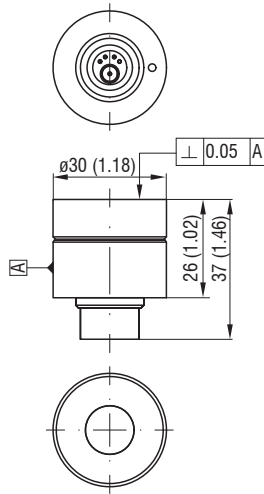

Fig. 5 Dimensional drawing of sensor

➤ When mounting the sensor, make sure that there are no metallic conductive objects in the area marked in gray. Losses in accuracy cannot be ruled out.

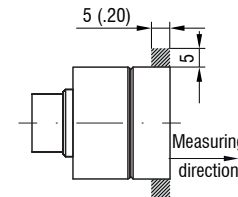
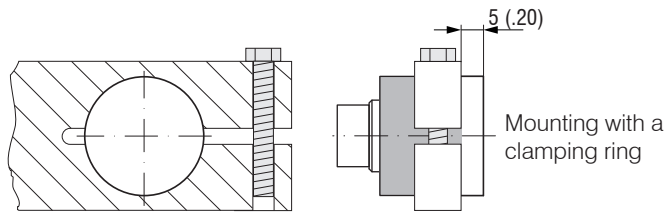

Fig. 6 Clearance of metallic conductive objects

Dimensions in mm (inches, rounded off)

Circumferential Clamping

This type of sensor installation ensures the highest level of reliability because the sensor's cylindrical cover is clamped over a relatively large area. It is imperative in complex installation environments, such as machines, production plants, etc.



i Tension on the cable is not permitted.

Fig. 7 Circumferential clamping

4.3 Sensor Cable

The sensor cable connects the sensor to the controller.

▶ Connect the sensor with the controller via the sensor cable provided.

This is done simply by plugging it in. The plug connection will lock automatically. You can check that the fit is tight by pulling on the connector housing (cable socket).

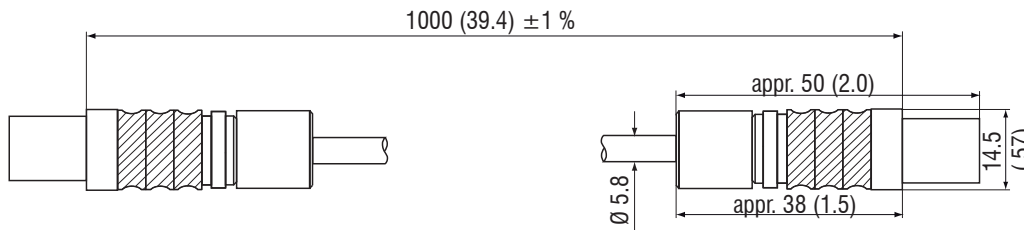

i A damaged sensor cable cannot be repaired.

Fig. 8 Dimensional drawing of sensor cable, dimensions in mm (inches, rounded off)

4.4 Controller

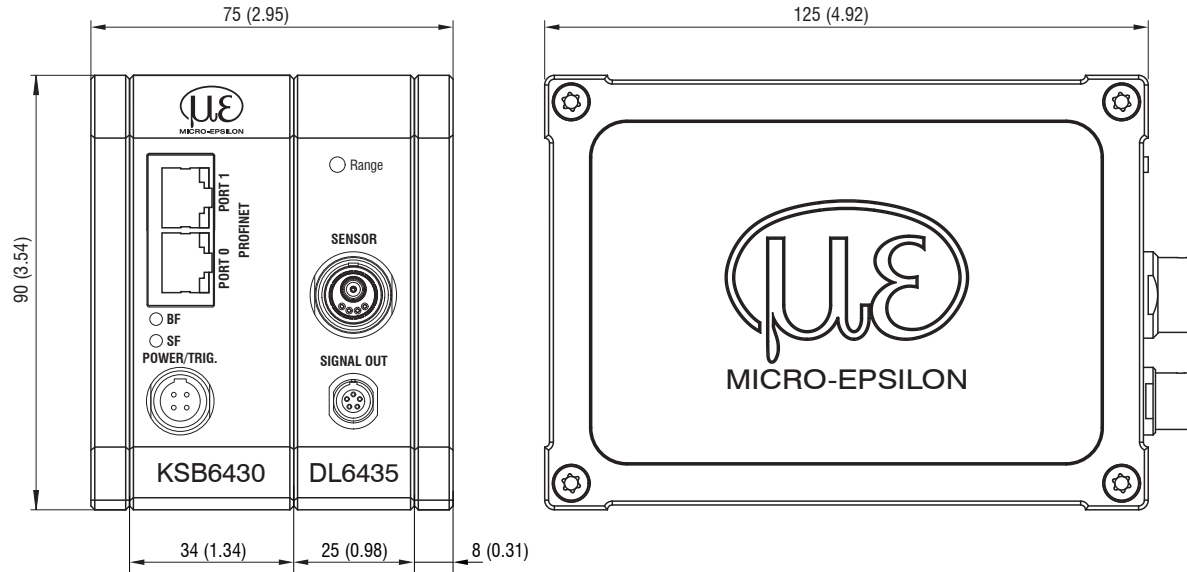
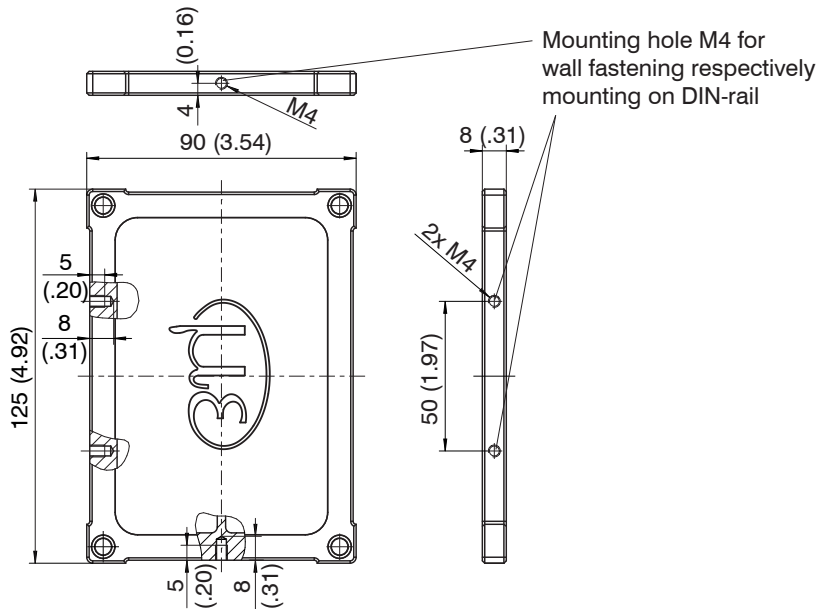

Fig. 9 Dimensional drawing of controller with base unit, demodulator and housing cover, dimensions in mm (inches, rounded off)



Mounting hole M4 for wall fastening respectively mounting on DIN-rail

Fig. 10 Dimensional drawing of housing cover, dimensions in mm (inches, rounded off)

4.5 Ground Connection, Grounding

➡ Ensure sufficient grounding of the target, for example by connecting it to the sensor or the power supply ground.

If necessary, use the grounding connection on the housing cover. The grounding connection is included in the conversion kit supplied in the scope of delivery.

4.6 Electrical Connections

4.6.1 Connection Possibilities

The power supply and the signal output are located at the front side of the controller.

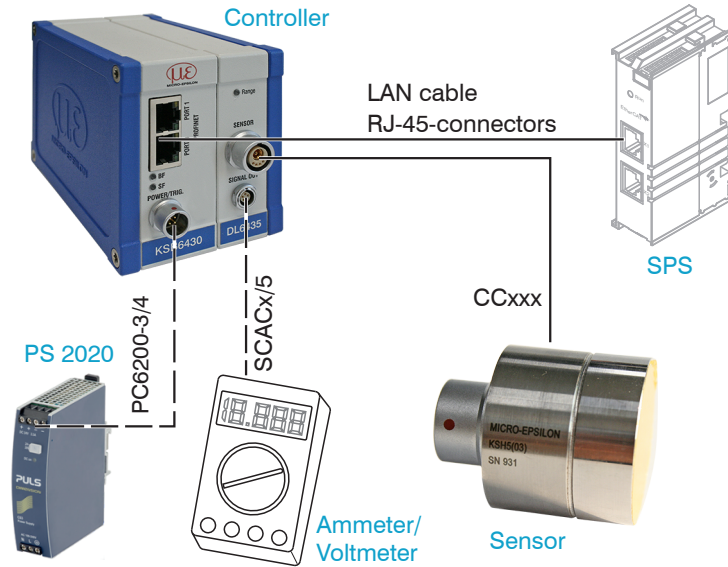
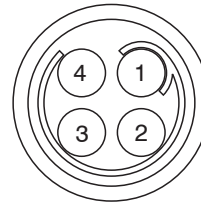

Fig. 11 Measuring system structure

4.6.2 Pin Assignment Supply, Trigger

PIN	Wire color PC6200-3/4	Signal	Description
1	brown	+24VIN	+24 VDC supply
2	white	Zero VIN	GND supply
3	yellow	TRI_IN+	Trigger IN+, TTL level
4	green	TRI_IN-	Trigger IN-
Shield			



View: solder side,
4-pin ODU port

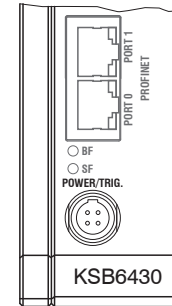

Supply input on controller,
4-pin plug

PC6200-3/4 is an assembled supply and trigger cable that is 3 m long.

4.6.3 Analog Output

The signals are output via the 5-pin built-in socket. For pin assignment, see drawing and table.

PIN	Wire color SCAC3/5	Description
1	white	Differential signals (= eddy current signal - capacitive signal) or thickness signal (0 ... 10 V)
2	gray	Capacitive signal 0 ... 10 V
3	yellow	Eddy current signal 0 ... 10 V
4	green	Temperature signal of sensor, not scaled
5	brown	GND

The SCAC3/5 is an assembled 5-core supply and output cable that is 3 m long. It is supplied as an optional accessory.

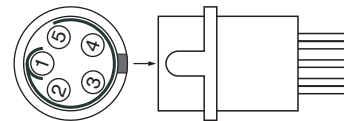

Solder pin side
male cable connector

4.7 Fieldbus Cabling

During cabling, channel 0 of the IO controller is connected to a port on the first IO device (slave device). The second port of the first slave device is connected to the input port of the next slave device, etc. One port of the last slave device and channel 1 of the master device remain unused.

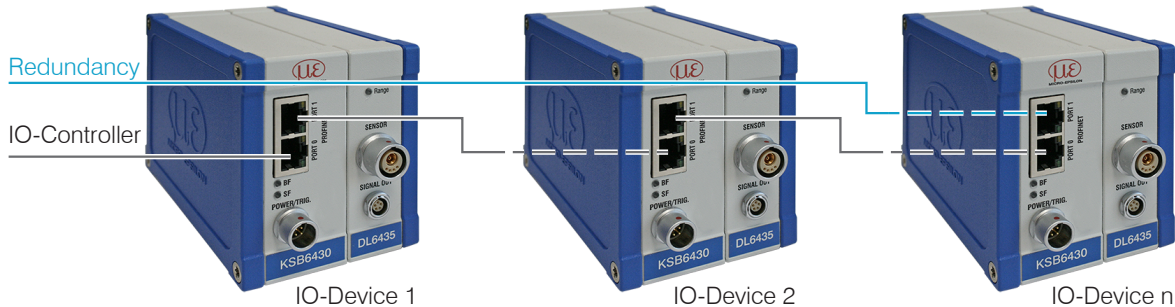

Fig. 12 Cabling in the PROFINET IO network

Optional: You achieve greater failsafe network performance if you implement an additional redundant connection (MRP = Media Redundancy Protocol) between the output port of the last slave device and channel 1 of the IO controller. The KSB6430 can participate in an MRP ring as a client; however, it cannot manage the ring. To achieve ring functionality, all participants must be configured as ring participants.

5. Operation





5.1 Initial Operation

➔ Connect the display/output devices via the signal output socket, [see 4.6](#) before connecting the device to the supply voltage and switching it on.

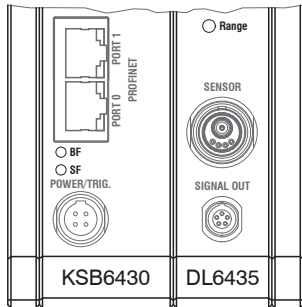
i Let the measuring system warm up for about 15 minutes after applying the supply voltage.

5.2 Controller LEDs



LED	Color		Function
Range		green	Measuring object in measuring range
		red	Measuring range exceeded
BF		red	Bus failure
SF		red	System failure
BF, SF		off	System ok

5.3 Triggering

The measured value output of the combiSENSOR KSB6430 can be started via an external trigger signal or a software command. Only the digital output is affected.

Triggering takes place via:

- Trigger input (pin 3 and pin 4 on 4-pole power supply connector or
- $U_{IN} \text{ HIGH} \geq 2.0 \text{ V}$
- $U_{IN} \text{ LOW} \leq 0.8 \text{ V}$

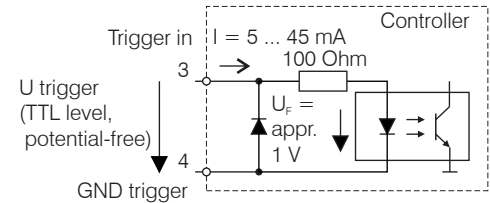
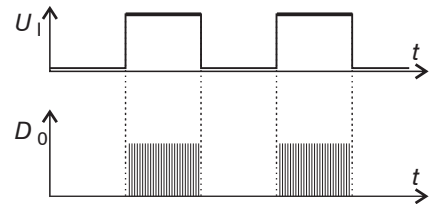

Fig. 13 Trigger input

The trigger type is determined by the parameters of the PROFINET device used.

Level triggering (High level) Continuous measured value output with set data rate for as long as the selected level is active. After that the controller outputs the last value. The measured value counter is not incremented any further.

Fig. 14 Active level triggering with high level (U_I), associated digital signal (D_0)



Edge triggering. Starts the measured value output as soon as the selected edge is present at the trigger input. If the trigger condition is met, the controller outputs the specified number of measured values. The set data rate must be greater than the maximum trigger frequency. If triggering is faster than the set data rate, individual measured values are sent twice because no new measured values are available internally from the AD converter.

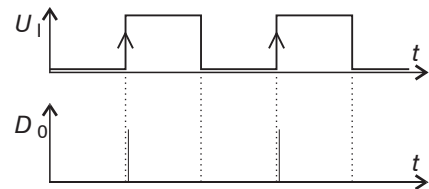

The duration of the pulse must be at least $5 \mu\text{s}$.

Fig. 15 Rising edge triggering (U_I), associated digital signal (D_0)

Rising edge (gate). Starts measured value output with set data rate as soon as the rising edge is present at the trigger input. Another rising edge stops the output of measured values or switches it on again.

Fig. 16 Rising edge trigger (U_i), relevant digital signal (D_o)

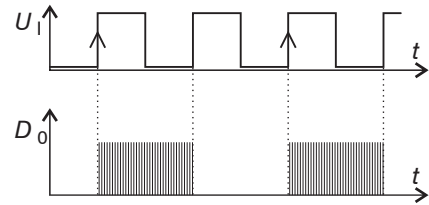

There is no factory-set triggering, the controller starts transmitting data as soon as it is switched on.

5.4 Measurement Averaging

5.4.1 Preliminary Remarks

The measured values are averages before they are output via the PROFINET interface.

The averaged measurements improve the resolution, enable to mask individual interfering points or "smooth" the measurement result.

i The linearity behavior is not affected by averaging. Averaging has no effect on the data rate.

The controller is shipped from the factory without averaging.

5.4.2 Moving Mean

The definable number N for successive measurements is used to calculate the arithmetic average M_{mov} according to the following formula:

$$M_{mov} = \frac{\sum_{k=1}^N MV(k)}{N}$$

MV = measurement value
 N = number
 k = continuous index
 M_{mov} = average

Fig. 17 Formula for moving average

Method

Each new measured value is added, the first (oldest) measured value is removed from the averaging.

Example with N = 7:

... 0 1 2 3 4 5 6 7 8 becomes $\frac{2+3+4+5+6+7+8}{7}$ average n

... 1 2 3 4 5 6 7 8 9 becomes $\frac{3+4+5+6+7+8+9}{7}$ average n + 1

5.4.3 Arithmetic Average

The arithmetic average M is formed and output via the selectable number N of successive measured values.

Method

Measured values are collected based on which the mean value is calculated. This method leads to a reduced amount of data because an average value is only output after every Nth measured values.

Example with N = 3:

... 0 1 2 3 4... becomes $\frac{2+3+4}{3}$ average n

... 3 4 5 6 7... becomes $\frac{5+6+7}{3}$ average n + 1

5.4.4 Median

A median value is formed from a preselected number N of measurements. For this purpose, the incoming measurement values are re-sorted after each measurement. The median value is then output as the median.

If an even value is selected for median N, the two median measurement values are added and divided by two.

Example with N = 7:

... 2 4 0 1 2 4 5 1 3 Measurement value sorted 0 1 1 2 3 4 5 median $n = 2$

... 4 0 1 2 4 5 1 3 4 Measurement value sorted 1 1 2 3 4 4 5 median $n+1 = 3$

5.4.5 Dynamic Noise Suppression

This filter entirely eliminates the noise of the measured values but maintains the original bandwidth of the measuring signal. For this purpose, the noise is calculated dynamically and changes in the measured values are only accepted if they are greater than this calculated noise. However, this can cause small hysteresis effects in the order of magnitude of the calculated noise when the direction of the measurement signal changes.

6. Initial Operation

6.1 General

This section describes how to use a SIMATIC S7 controller with Micro-Epsilon sensors (controller).

6.2 Basic Settings Module

After setting up the KSB6430 in the TIA Portal, see Chap. A 2, the `Input_1` module is an easy way to make the necessary settings

The screenshot displays the TIA Portal interface for configuring a 4 Channel Input_1 module. The top window shows a rack diagram with the module installed in slot 1. The 'Device overview' table is as follows:

Module	Rack	Slot	I address	Q address
myksb6430pnet	0	0		
▶ PFI-O	0	0 X1		
4 Channel Input_1	0	1	68..95	
	0	2		

The bottom window shows the '4 Channel Input_1 [4 Channel Input]' configuration page. The 'General' tab is active, displaying the following settings:

- Trigger Settings:** Trigger Settings: OFF
- Sample Time Interval/Measure rate:** Sample Time Interval/Measure rate: 256µs / 3906.3Hz
- Thickness function:**
 - Thickness function: On
 - Dielectric constant: 9999999.0000
 - Offset (µm): 0.0000
 - Max. working distance (µm): 5000.0000

6.3 Data Format

All configuration parameters and data are transmitted in Little Endian format.

1		LSB	17	Channel 2 (μm)	LSB
2	Timestamp (ms) DWord, Little Endian	...	18	Channel 2 (μm) Real 32bit, Little Endian	...
3		...	19		...
4		MSB	20		MSB
5	Error Code DWord, Little Endian	LSB	21	Channel 3 (μm) Real 32bit, Little Endian	LSB
6		...	22		...
7		...	23		...
8		MSB	24		MSB
9	Sensor Counter Word, Little Endian	LSB	25	Channel 4 (μm) Real 32bit, Little Endian	LSB
10		MSB	26		...
11	Number of Values, Byte		27		...
12	Reserved		28		MSB
13	Channel 1 (μm) Thickness signal Real 32bit, Little Endian	LSB			
14		...			
15		...			
16		MSB			

Default tag table							
	Name	Data type	Address	Retain	Acces...	Writa...	Visibl...
1	timestamp	DWord	%ID0	<input type="checkbox"/>	<input checked="" type="checkbox"/>	<input checked="" type="checkbox"/>	<input checked="" type="checkbox"/>
2	lasterror	DWord	%ID4	<input type="checkbox"/>	<input checked="" type="checkbox"/>	<input checked="" type="checkbox"/>	<input checked="" type="checkbox"/>
3	a	DWord	%ID8	<input type="checkbox"/>	<input checked="" type="checkbox"/>	<input checked="" type="checkbox"/>	<input checked="" type="checkbox"/>
4	c1	DWord	%ID12	<input type="checkbox"/>	<input checked="" type="checkbox"/>	<input checked="" type="checkbox"/>	<input checked="" type="checkbox"/>
5	c2	DWord	%ID16	<input type="checkbox"/>	<input checked="" type="checkbox"/>	<input checked="" type="checkbox"/>	<input checked="" type="checkbox"/>
6	c3	DWord	%ID20	<input type="checkbox"/>	<input checked="" type="checkbox"/>	<input checked="" type="checkbox"/>	<input checked="" type="checkbox"/>
7	c4	DWord	%ID24	<input type="checkbox"/>	<input checked="" type="checkbox"/>	<input checked="" type="checkbox"/>	<input checked="" type="checkbox"/>
8	c1_le	Real	%ID28	<input type="checkbox"/>	<input checked="" type="checkbox"/>	<input checked="" type="checkbox"/>	<input checked="" type="checkbox"/>
9	c2_le	Real	%ID32	<input type="checkbox"/>	<input checked="" type="checkbox"/>	<input checked="" type="checkbox"/>	<input checked="" type="checkbox"/>
10	c3_le	Real	%ID36	<input type="checkbox"/>	<input checked="" type="checkbox"/>	<input checked="" type="checkbox"/>	<input checked="" type="checkbox"/>

```

9      #tmp_dword.%B0 := "c1".%B3;
10     #tmp_dword.%B1 := "c1".%B2;
11     #tmp_dword.%B2 := "c1".%B1;
12     #tmp_dword.%B3 := "c1".%B0;
13     "c1_le" := DWORD_TO_REAL(#tmp_dword);
14

```

Fig. 18 Data format and conversion of a DWORD to REAL

The IO-Area contains the data as shown, see Fig. 18:

Timestamp	Milliseconds passed since device power up
Error Code	Status code of the communication module
Sensor Counter	Sequential number of currently transmitted sample
Number of values	Sensor values collected since last communication cycle
Reserved	Reserved
Channel 1	Thickness in μm calculated based on channel measurement range and offset
....	

6.4 Object Directory

6.4.1 Error Protocol

Index	Subindex	Data type		Name	Description
0x2010	0	Uint32[64]	R	device error log	Reads out the last 32 error codes with time stamp

6.4.2 Device Reset

Index	Subindex	Data type		Name	Description
0x2026	0	Uint8	W	reset device	One byte performs reset/restart

6.4.3 Triggering

Index	Subindex	Data type		Name	Description
0x2031	1	Uint16	RW	Trigger settings	0: No trigger 1: Rising edge, a measured value is output 4: High level, value output as long as the level is active 16: Gate trigger with rising edge, starts or stops the output of measurement values

6.4.4 Filter Settings

Index	Subindex	Data type		Name	Description
0x2032	1	8 bytes	RW	Filter Settings	
		UInt16		Filter type	0: No filter 1: Moving average 2: Arithmetic average 4: Median
		UInt16		Reserved	
		UInt32		Filter value	Filter length: 2 / 3 / 4 / 5 / 6 / 7 / 8

6.4.5 Sample Time

Index	Subindex	Data type		Name	Description
0x2036	1	UInt32	RW	Sample time interval	256: 3906.3 Hz 480: 2083.3 Hz 960: 1041.7 Hz 1920: 520.8 Hz 9600: 104.2 Hz 16000: 62.5 Hz 19200: 52.1 Hz 32000: 31.3 Hz 38400: 26 Hz

6.4.6 Thickness Measurements

Index	Subindex	Data type		Name	Description
0x2037	1	16 bytes	RW	Thickness measurement function	
		UInt8	RW	Activate	0: Not active 1: Active
		UInt8	RW	Reserved	Value 0
		UInt8	RW	Reserved	Value 0
		UInt8	RW	Reserved	Value 0
		Float32	RW	ϵ_r	Dielectric constant (float > 1)
		Float32	RW	Offset	Offset, in μm of the result (float)
		Float32	RW	Working distance	Max. working distance, n μm of the sensor used

6.4.7 Thickness Measurement Zero Setting

Index	Subindex	Data type		Name	Description
0x2038	1	UInt8_t	W	Thickness Zeroing	1: Activates zero setting

6.5 Sequence when Writing and Reading Acyclical Data

➡ Determine the hardware identification (ID) of the module. To do this, switch to the **General > PROFINET interface > Advanced options** tab.

In the example to the right, you get the value 273.

On the SPS, WRREC_DB with input parameters (:=) is called.

REQ // Start execution

ID // Hardware ID of the target device addressed

INDEX // Target address in the object directory

LEN // Length of the binary data block to be written

RECORD // Usable data for writing

RECORD, VALID, BUSY, ERROR, STATUS and LEN contain return parameters (= >) that allow for determining the success or progress of the write command.

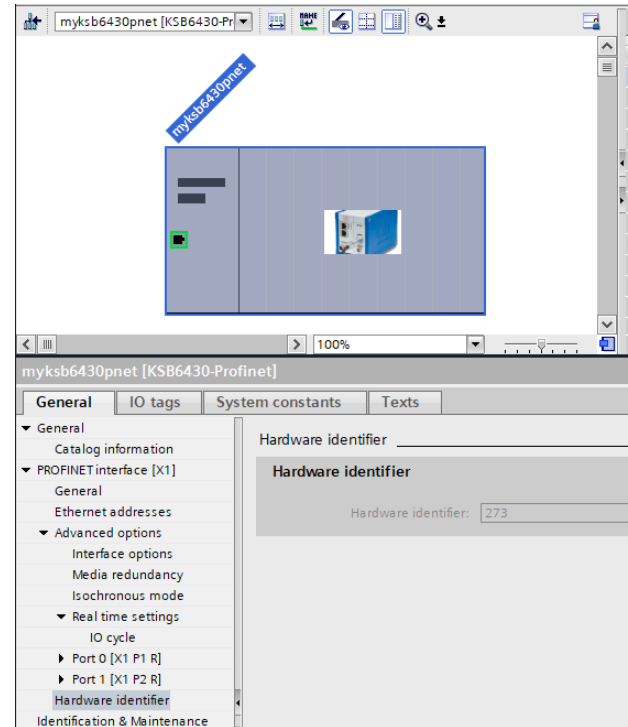

6.6 Sequence when Writing Structured Data

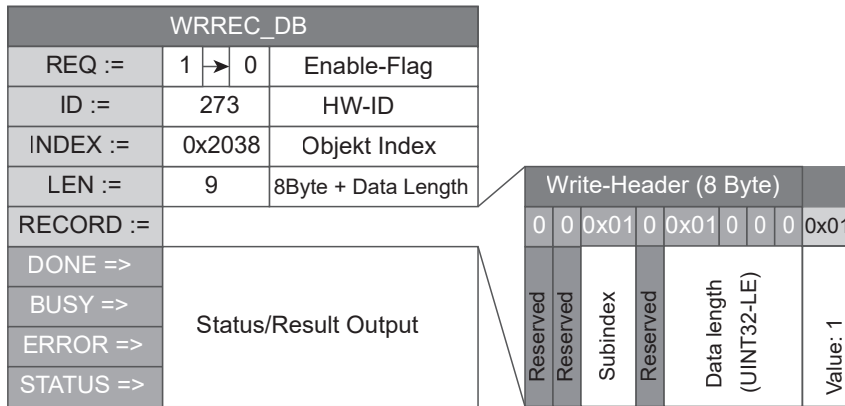

Fig. 19 Write command with data from PLC to capaNCDT 6430

7. Operation and Maintenance

Please observe the following principles:

- ▶ Ensure that the sensor surface is always clean.
- ▶ Before cleaning, turn off the supply voltage.
- ▶ Clean with a damp cloth and then rub the sensor surface dry.

If the target has been changed or operating periods are very long, minor losses in operating quality are possible. You can correct these long-term errors by recalibrating.

- ▶ Disconnect the power supply before touching the sensor surface.

> Static discharge

> Risk of injury



If the controller, sensor or sensor cable is defective:

- If possible, save the current settings in a parameter set to reload them into the controller after the repair.
- Please send us the affected parts for repair or exchange.

If the cause of a fault cannot be clearly identified, please send the entire measuring system to:

MICRO-EPSILON MESSTECHNIK
GmbH & Co. KG
Koenigbacher Straße 15
94496 Ortenburg / Germany

Tel. +49 (0) 8542 / 168-0
Fax +49 (0) 8542 / 168-90
info@micro-epsilon.com
www.micro-epsilon.com

8. Disclaimer

All components of the device have been checked and tested for functionality in the factory. However, should any defects occur despite careful quality control, these shall be reported immediately to MICRO-EPSILON or to your distributor / retailer.

MICRO-EPSILON undertakes no liability whatsoever for damage, loss or costs caused by or related in any way to the product, in particular consequential damage, e.g., due to

- non-observance of these instructions/this manual,
- improper use or improper handling (in particular due to improper installation, commissioning, operation and maintenance) of the product,
- repairs or modifications by third parties,
- the use of force or other handling by unqualified persons.

This limitation of liability also applies to defects resulting from normal wear and tear (e.g., to wearing parts) and in the event of non-compliance with the specified maintenance intervals (if applicable).

MICRO-EPSILON is exclusively responsible for repairs. It is not permitted to make unauthorized structural and / or technical modifications or alterations to the product. In the interest of further development, MICRO-EPSILON reserves the right to modify the design.

In addition, the General Terms of Business of MICRO-EPSILON shall apply, which can be accessed under Legal details | Micro-Epsilon <https://www.micro-epsilon.com/legal-details/>

9. Decommissioning, Disposal

In order to avoid the release of environmentally harmful substances and to ensure the reuse of valuable raw materials, we draw your attention to the following regulations and obligations:

- Remove all cables from the sensor and/or controller.
- Dispose of the sensor and/or the controller, its components and accessories, as well as the packaging materials in compliance with the applicable country-specific waste treatment and disposal regulations of the region of use.
- You are obliged to comply with all relevant national laws and regulations.

For Germany / the EU, the following (disposal) instructions apply in particular:

- Waste equipment marked with a crossed garbage can must not be disposed of with normal industrial waste (e.g. residual waste can or the yellow recycling bin) and must be disposed of separately. This avoids hazards to the environment due to incorrect disposal and ensures proper recycling of the old appliances
- A list of national laws and contacts in the EU member states can be found at https://ec.europa.eu/environment/topics/waste-and-recycling/waste-electrical-and-electronic-equipment-weee_en.





Here you can inform yourself about the respective national collection and return points.

- Old devices can also be returned for disposal to MICRO-EPSILON at the address given in the imprint at <https://www.micro-epsilon.com/legal-details>
- We would like to point out that you are responsible for deleting the measurement-specific and personal data on the old devices to be disposed of.
- Under the registration number WEEE-Reg.-Nr. DE28605721, we are registered at the foundation Elektro-Altgeräte Register, Nordost-park 72, 90411 Nuremberg, as a manufacturer of electrical and/or electronic equipment.

Appendix

A 1 Accessories

SCACx/5		Signal output cable analog, length 3 m and 6 m
PS2020		Power supply for top-hat rail installation Input 230 VAC (115 VAC) Output 24 VDC/2.5 A; L/W/H 120 x 120 x 40 mm

A 2 Integration into TIA Portal

A 2.1 Importing KSB6430 into the Software

This section describes how to connect KSB6430 to SIMATIC S7 controllers.

- Start the TIA (Totally Integrated Automation) Portal. Therefore, either double-click the TIA Portal icon on your desktop or call up the framework via the start menu.
- Click on the Create new project button at the top left of the Start view. Enter a project name and confirm by clicking the Create button.

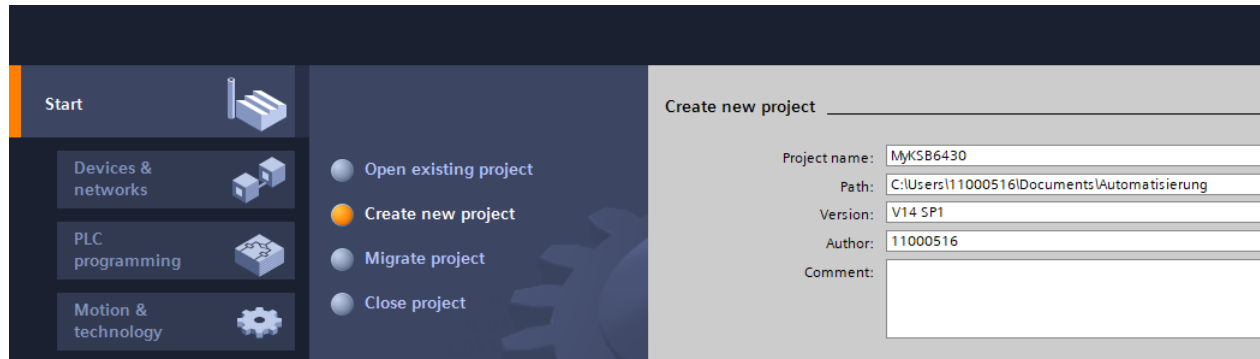

- Change to the portal Devices & networks

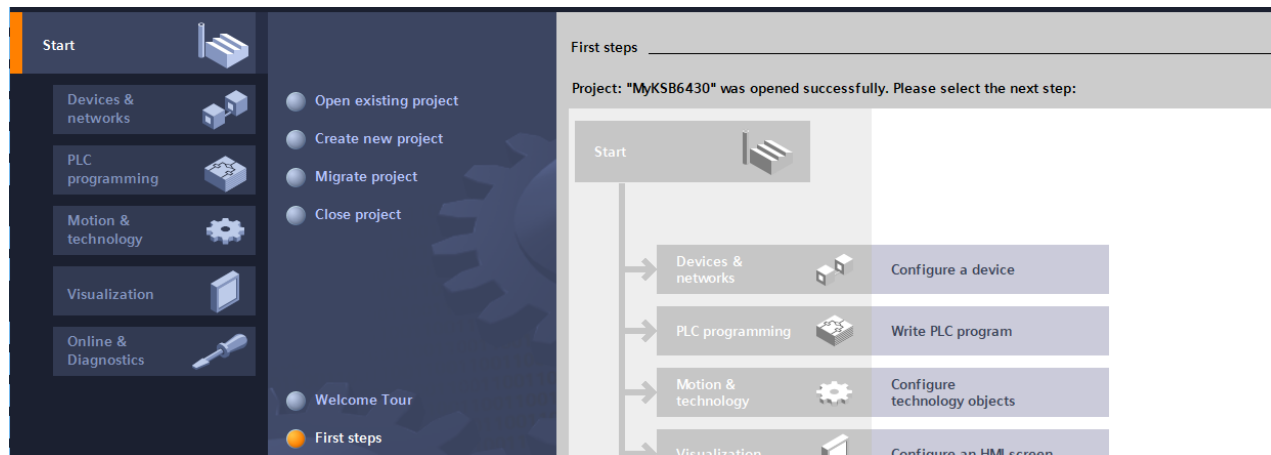

➔ Click Add new device. Select the S7 CPU series you are using in the device list and click the Add button. Make sure that the checkbox Open device view on the bottom left of the window is activated.

i Identify your CPU module based on the order number on the S7 device, its packaging, or the delivery note. Also select the correct firmware version.

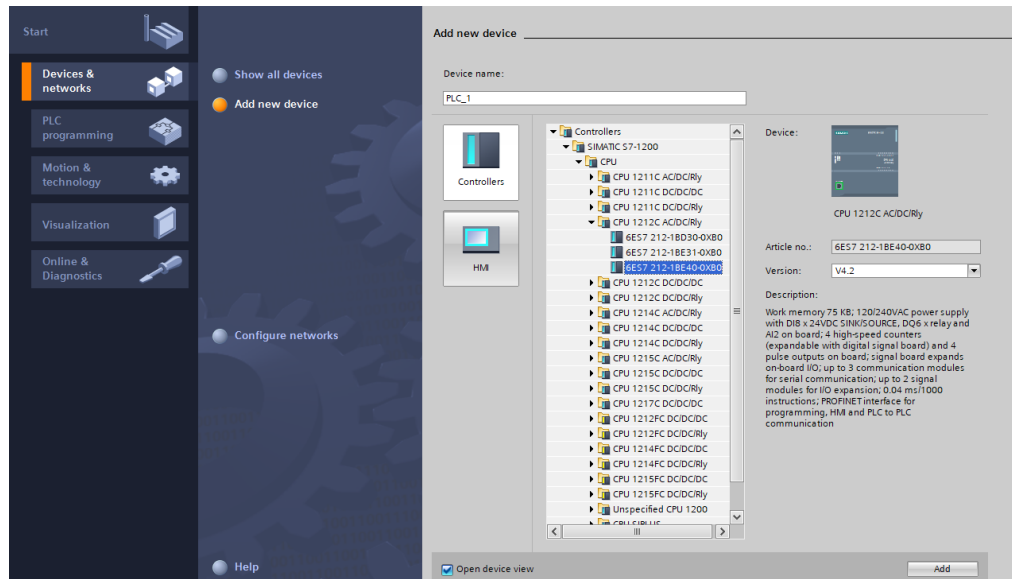

The software switches automatically to the **Project** view and displays the **Working** window (center of screen) in the **Device** view. Below, you can find the **Inspection** window which shows the parameterization options of the selected PLC in the **Properties** register.

i The TIA Portal automatically assigns the IP address and subnet mask. You can manually adjust these data here (**General** > **PROFINET** interface > **Ethernet** addresses) if necessary and save them by clicking the **Save project** button, see top left corner in the **Toolbar**.

The **GSDML** file contains information about a **PROFINET** device. This file is needed for the **PROFINET** controller and must be integrated into the corresponding configuration software. You get the **GSDML** file from **Micro-Epsilon**.

➡ Import the **GSDML** file. To do so, in the **Extras** > **Manage device description files (DDF)** menu, select the path for the file <**GSDML-V2.43-MICRO-EPSILON-KSB6430PNET-20231201.xml**>.

➔ Click the **Install** button.

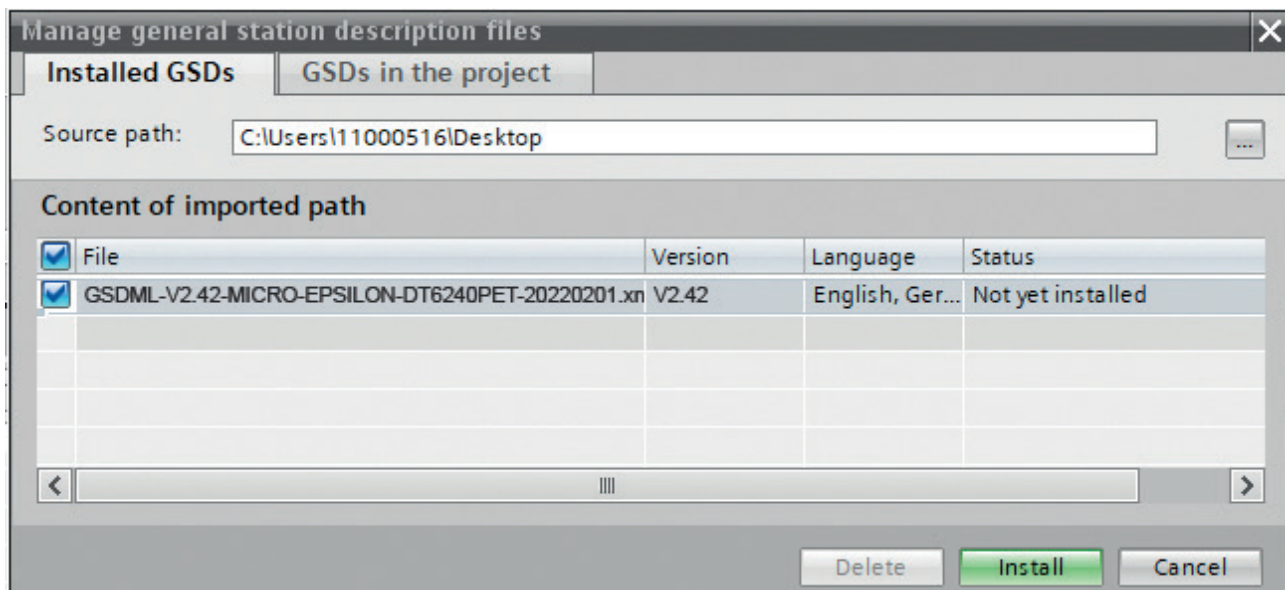
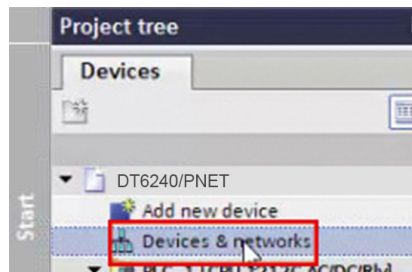

Fig. 20 Importing the device description file

After installation, switch to the project view.

➔ Click on **Devices & networks** in the Project navigation.



Add KSB6430 to the project. Make sure that KSB6430 has been integrated correctly.

➡ Wechseln Sie in den Reiter Hardware Catalog.

➡ In the menu, select Other field devices > PROFINET IO > I/O > MICRO-EPSILON MESSTECHNIK GmbH > PNS > KSB6430-PROFINET.

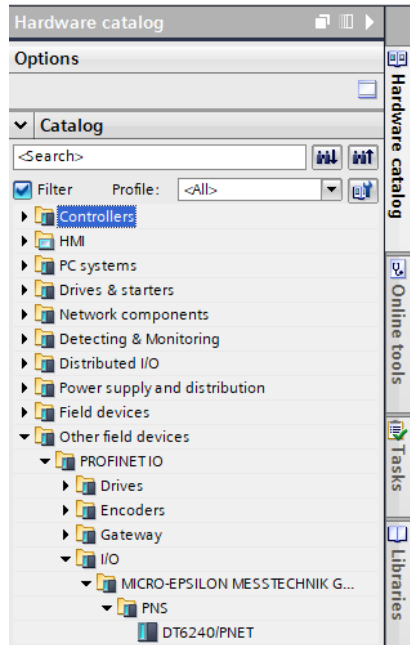

A 2.2 Unique Integration of KSB6430 into the PROFINET Network

➤ Switch to the **Network** view of the Working window and add **KSB6430-PROFINET** from the hardware catalog by drag and drop.

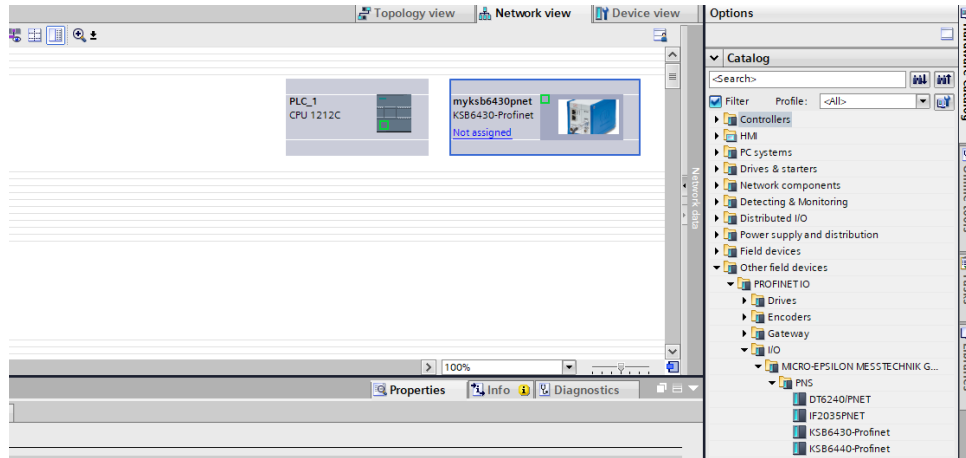

➤ Connect the **Port 0 LAN** socket of KSB6430 with the one of the PLC by clicking one of the green boxes with the left mouse button. Hold the button and draw the resulting line to the other green box in order to create a PROFINET subsystem.

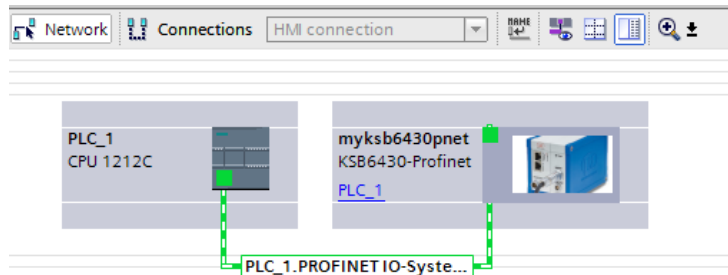

Enter the device name for identification in the PN network.

➤ Switch to the `Device` view, double-click your `KSB6430-PROFINET` and set its device name in the `Inspection` window (`Properties` > `General` tab).

i This is one of several possibilities to change the device name.

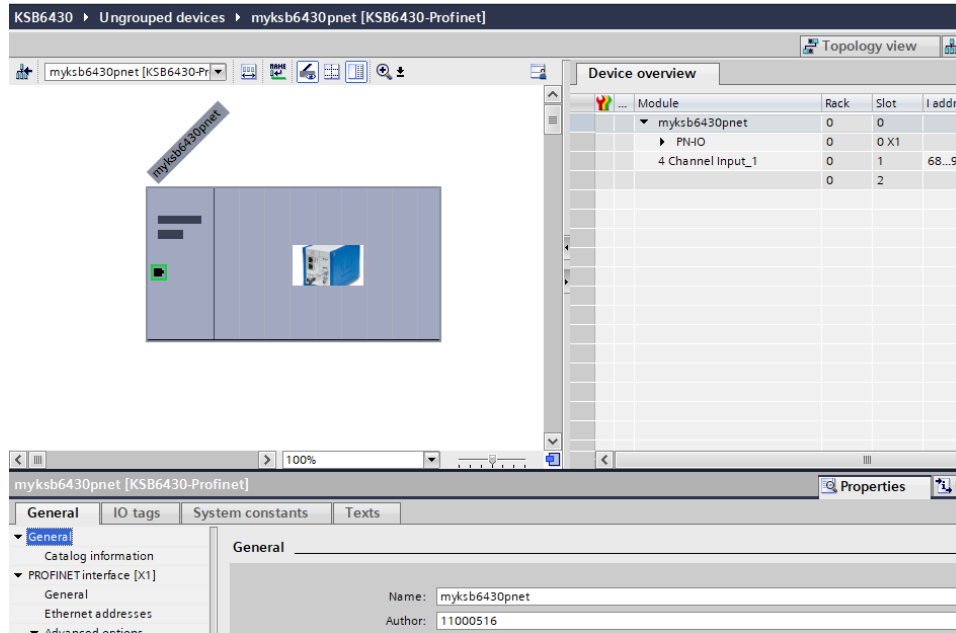

Fig. 21 Assigning a device name

i The device name is used to identify the device on the PN network and as an address; it must be unique across the entire system.

The change of name must be communicated to the PN network.

➤ Right-click on KSB6430-PROFINET.

You now reach the context menu shown.

➤ Select the Assign device name entry.

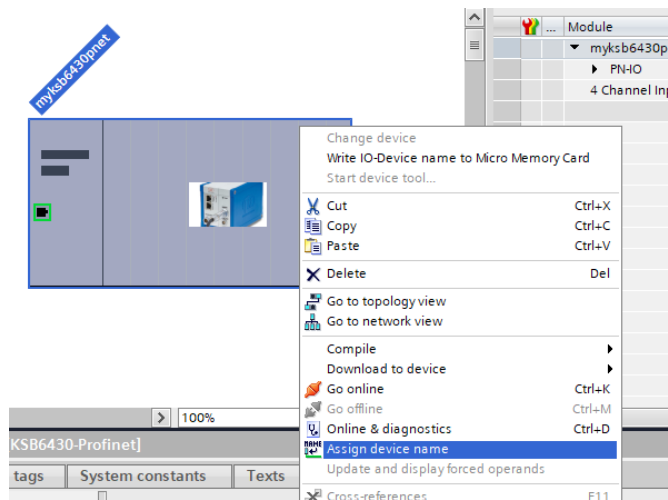

➤ In the open dialog window, click the Update list button.

Potential devices on the PN network are displayed.

➤ In the list that now appears, select the line with your KSB6430-PROFINET that is to receive the new name, field Status, device name is different. Finally, click the Assign name button.

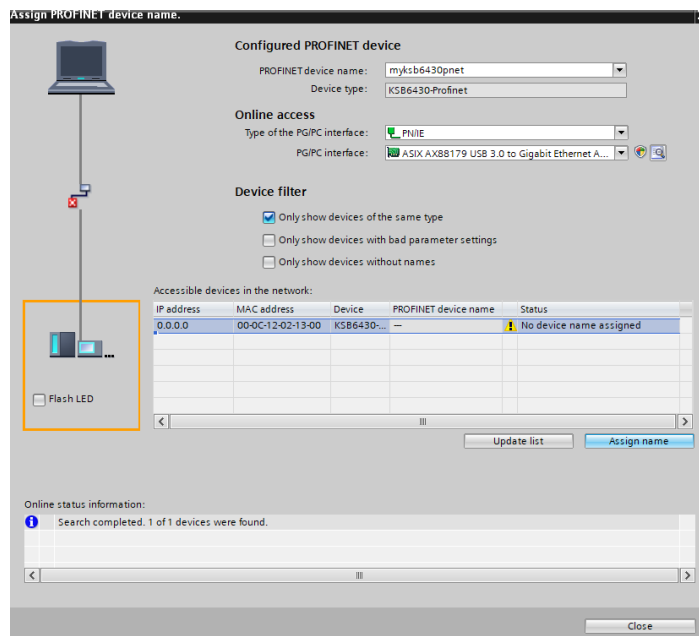
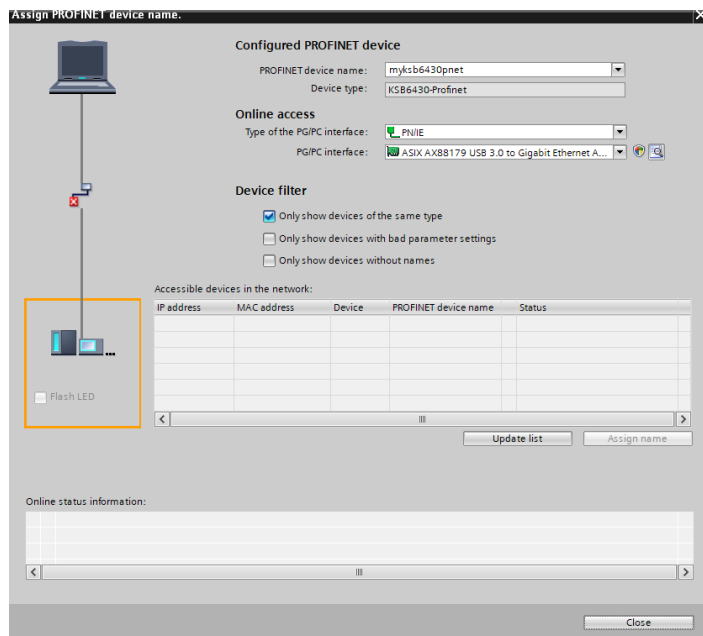

i If you activate the `Flash LED` checkbox in the orange highlighted area you can verify which device you are currently addressing. This is especially helpful in larger networks.

A 2.3 Loading the Configuration into the PLC

- Click on the **Download to device** button in the **Toolbar**. Alternatively, you can also right-click on the image of your **S7** in the **Network view** and select the function in the **Context menu**.
- In the **Dialog window** that opens, select the option **PN/IE_1** (the previously created PROFINET subsystem) under **Connection to interface/subnet**. Then click the **Start search** button. Next, select your target PLC in the displayed list. Click on the **Load** button to transfer the hardware configuration.

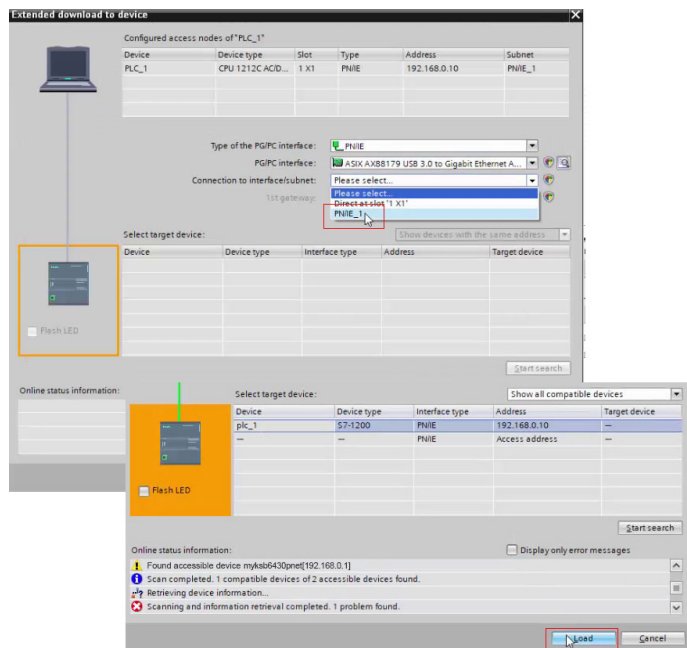

The **Load** preview dialog box opens.

➤ Select the `Stop all` option under `Stop modules`.

The device configuration can only be loaded when the CPU is in the operating state `STOP`.

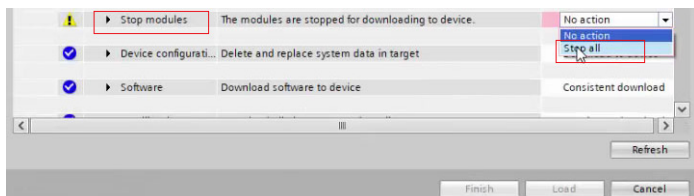

i Depending on whether you created a new project or opened an existing one, it might be necessary to overwrite the so-called additional information. The latter is recommended to ensure an up-to-date data pool. This can be done by scrolling downwards within the same dialog and checking the `Replace all` box at `Device configuration`.

➤ Click the `Load` button. The PLC is thereby introduced to its environment for the first time. The loading process is indicated visually by a red flashing LED of the S7 device.

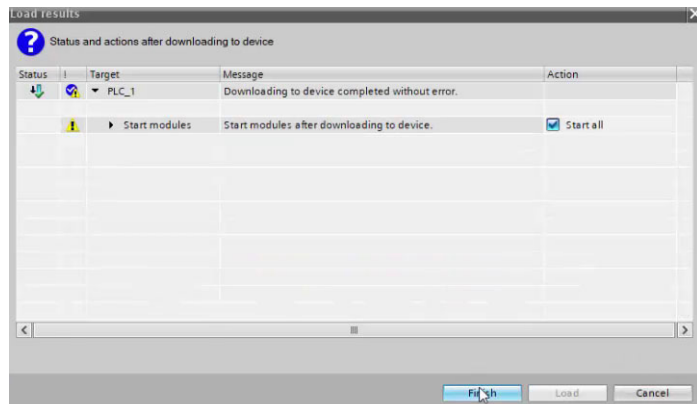

The results of the loading process are displayed in the following Dialog box. If the process was completed successful, start your S7. Activate the `Start all` checkbox, if necessary, and click the `Finish` button.

If no error occurs, the S7 changes to the operating state `RUN` which is indicated by the green `RUN`-LED.

A 2.4 Accessing Input and Output Data

- Switch to the **Device view** and take a look at the **Device overview** of KSB6430. Memorize the start address of the input module as an example.

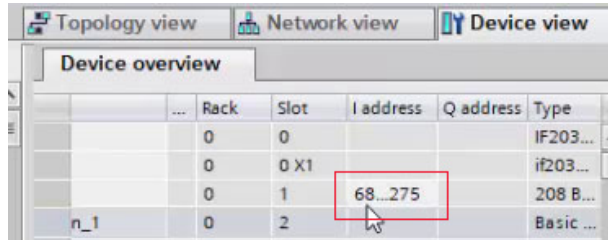

...	Rack	Slot	I address	Q address	Type
	0	0			IF203...
	0	0 X1			if203...
	0	1	68...275		208 B...
n_1	0	2			Basic ...

Depending on the module, the address space (memory address bytes) is visible in the **I address** or the **Q address** columns. These addresses are automatically assigned to the respective module depending on the slot.

- Go to the **Project tree**. Follow this path in your PLC:
 PLC tags > Default tag table. The latter opens in the Working window by double-clicking.

You can now define variables in the **Tag register** to read out the desired memory locations. Each PLC tag is assigned a name, a data type, and an address.

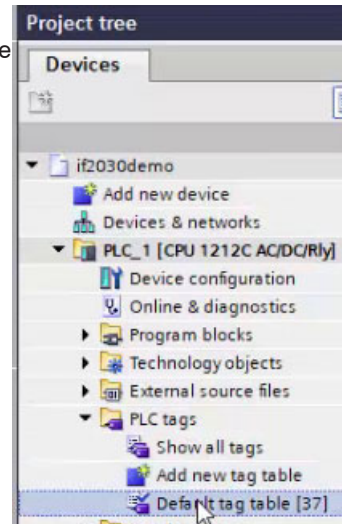

Proceed as follows to read out the content of the input module at its start address:

➡ Assign a (tag) Name and select the Data type DWord.

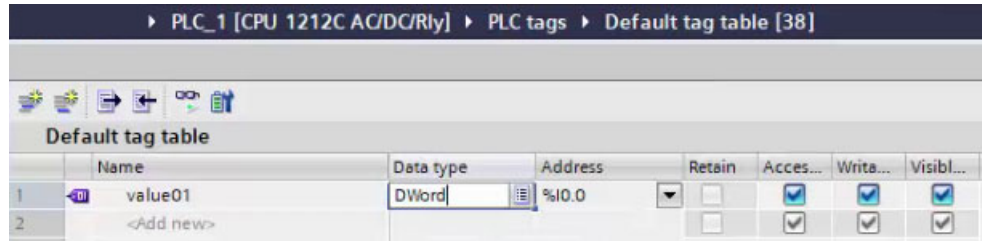

➡ Open the extended view of the Address definition. This facilitates the correct specification of operand and memory space. Enter the start address from Point 1 and confirm the entry by clicking the symbol button with the green check mark.

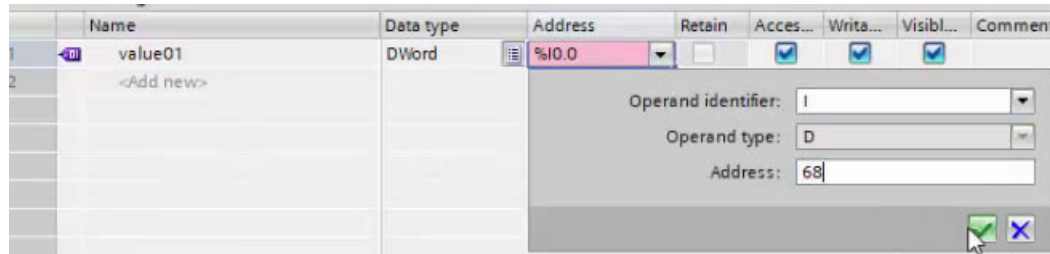

- You can monitor the values of the PLC tags in online mode directly via the Default tag table. Click either the Monitor all symbol button (monitor all symbols) in the Toolbar or select this function by right-clicking within the tag table.

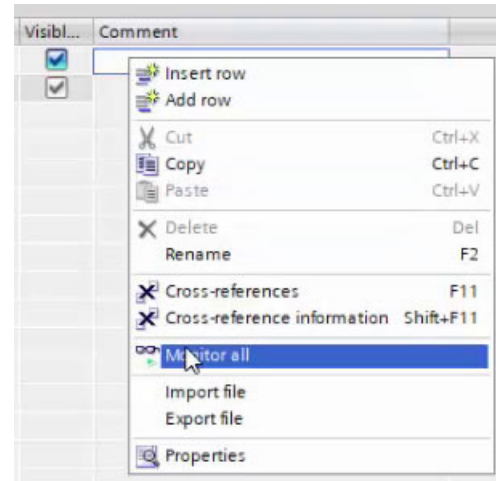

This leads to the online mode and the column Monitor value is displayed in the table. Clicking the symbol button once again quits the monitor mode.

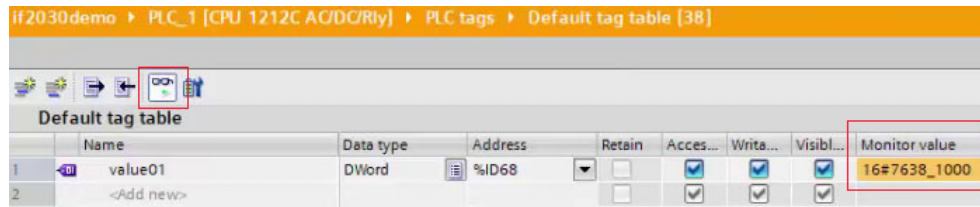



MICRO-EPSILON MESSTECHNIK GmbH & Co. KG
Koenigbacher Str. 15 · 94496 Ortenburg / Germany
Tel. +49 (0) 8542 / 168-0 · Fax +49 (0) 8542 / 168-90
info@micro-epsilon.com · www.micro-epsilon.com
Your local contact: www.micro-epsilon.com/contact/worldwide/

X9751485-A012094TSw
© MICRO-EPSILON MESSTECHNIK